

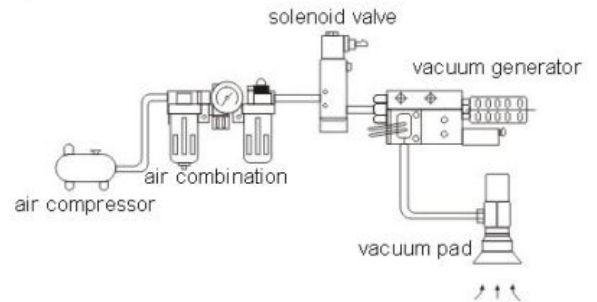

## Application



## Theoretical suction force

pad diameter(mm)	Φ2.5	Φ3.5	Φ6	Φ8	Φ10	Φ15	Φ20	Φ25	Φ30	Φ35	Φ40	Φ50
pad area Acm <sup>2</sup>	0.049	0.096	0.283	0.502	0.785	1.766	3.14	4.906	7.065	9.616	12.56	19.63
vacuum,												
-93.3 (-700)	0.457 (0.047)	0.896 (0.091)	2.64 (0.269)	4.68 (0.48)	7.32 (0.75)	16.48 (1.68)	29.3 (2.99)	45.8 (4.67)	65.9 (6.72)	89.7 (9.15)	117.2 (11.95)	183.1 (18.63)
-80 (-600)	0.392 (0.040)	0.768 (0.078)	2.26 (0.231)	4.02 (0.41)	6.28 (0.64)	14.13 (1.44)	25.1 (2.56)	39.2 (4.00)	56.5 (5.76)	76.9 (7.84)	100.5 (10.24)	157.0 (16.01)
-66.7 (-500)	0.327 (0.033)	0.640 (0.065)	1.89 (0.192)	3.35 (0.34)	5.24 (0.53)	11.78 (1.20)	20.9 (2.13)	32.7 (3.33)	47.1 (4.80)	64.1 (6.54)	83.8 (8.54)	130.9 (13.34)
-53.3 (-400)	0.261 (0.027)	0.512 (0.052)	1.51 (0.154)	2.68 (0.27)	4.18 (0.43)	9.41 (0.96)	16.7 (1.71)	26.1 (2.67)	37.7 (3.84)	51.3 (5.23)	68.9 (6.83)	104.6 (10.67)
-40 (-300)	0.196 (0.020)	0.384 (0.039)	1.13 (0.115)	2.01 (0.20)	3.14 (0.32)	7.00 (0.72)	12.6 (1.26)	19.6 (2.00)	28.3 (2.88)	38.5 (3.92)	50.2 (5.12)	78.5 (8.00)
-26.7 (-200)	0.131 (0.013)	0.256 (0.025)	0.76 (0.077)	1.34 (0.14)	2.10 (0.21)	4.72 (0.48)	8.4 (0.85)	13.1 (1.33)	18.9 (1.92)	25.7 (2.61)	33.5 (3.41)	52.4 (5.34)
-13.3 (-100)	0.065 (0.007)	0.128 (0.013)	0.58 (0.059)	0.67 (0.07)	1.04 (0.11)	2.35 (0.24)	4.2 (0.43)	6.5 (0.67)	9.4 (0.96)	12.8 (1.31)	16.7 (1.71)	26.1 (2.67)

## Pad material and features

Item	drawing	stretch level	Gas	Benzol	weather	ozone	high temp.	cold	chemical	anti-abrasion	acid	water	electrical insulation	hardness
NBR(N)	○	○	○	△	○	○	○	×	○	○	○	○	○	70±5
silicon rubber (S)	△	○	△	△	○	○	○	○	○	×	×	○	○	50±5
PU (U)	○	○	○	○	○	○	×	○	○	○	×	△	○	70±5

explain: ○ suit; △ unsuit; × ban use ○ can use

## Ordering Code



# Type of pad

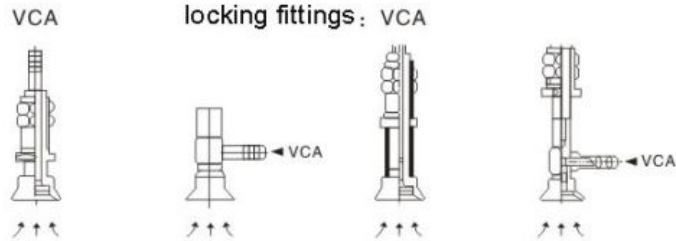

# Pad size

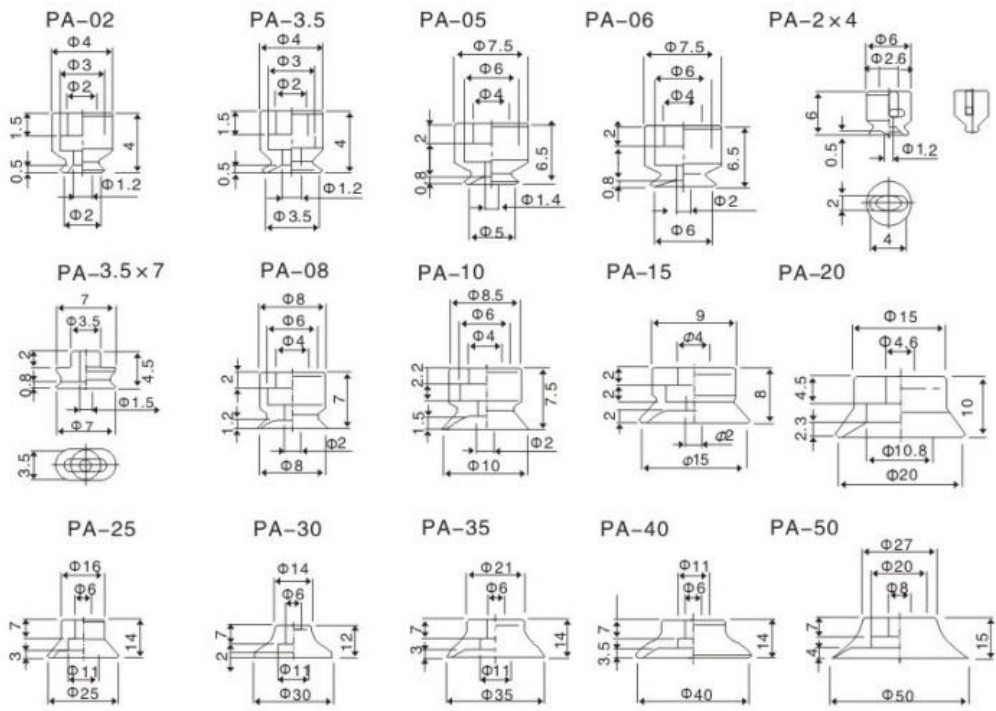

Φ2-Φ3.5

Pad type	Item	Disk diameter	Length B	Tube size
Round pad	PAF-2	Φ2	23.5	PU tube Φ4 × Φ2.5
	PAF-3.5	Φ3.5	23.5	
Ellipse pad	PAF-2 × 4	2 × 4	24.7	
	PAF-3.5 × 7	3.5 × 7	25.5	

Φ5-Φ8

Pad type	Item	Disk diameter	Length B	Tube size
Round pad	PAF-05	Φ5	38	PU tube Φ6 × Φ4
	PAF-06	Φ6	38	
	PAF-08	Φ8	38.5	

Φ10-Φ15

Pad type	Item	Disk diameter	Length B	Tube size
Round pad	PAF-10	Φ10	45.5	PU tube Φ6 × Φ4
	PAF-15	Φ15	46	

Φ25-Φ50

Pad type	Item	Disk diameter	Length B	Tube size
Round pad	PAF-20	Φ20	56	PU tube Φ6 × Φ4
	PAF-25	Φ25	60	
	PAF-30	Φ30	58	
	PAF-35	Φ35	62	
	PAF-40	Φ40	62	
	PAF-50	Φ50	63	

Outside graph dimension-PAT series

Φ2~Φ4

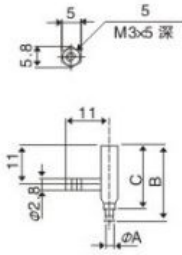

Φ10~Φ15

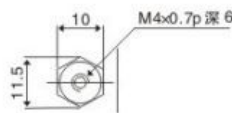
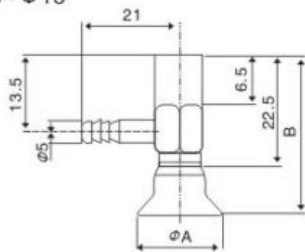

Φ5-Φ8

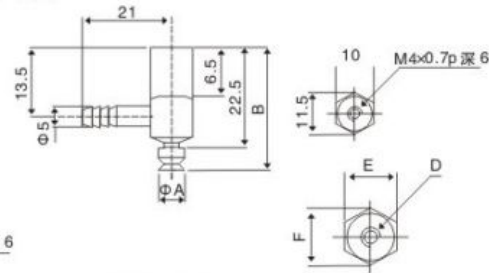

Φ25-Φ50

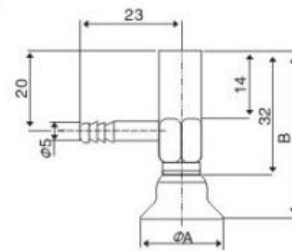

Φ2-Φ4

Pad type	Item	Disk diameter	Length	C	Tube size
Round pad	PAT-2	Φ2	20	16	PU tube Φ4 × Φ2.5
	PAT-3.5	Φ3.5	20		
Ellipse pad	PAT-2 × 4	2 × 4	21.7	20	
	PAT-3.5 × 7	3.5 × 7	22.5		

Φ25-Φ50

Pad type	Item	Disk diameter	Length	D	E	F	Tube size
Round pad	PAT-20	Φ20	42	M6 × 1 dp.8	14	16.5	PU tube Φ6 × Φ4
	PAT-25	Φ25	46				
	PAT-30	Φ30	44				
	PAT-35	Φ35	46				
	PAT-40	Φ40	46		15	17.3	
	PAT-50	Φ50	47				

Φ5-Φ8

Pad type	Item	Disk diameter	Length B	Tube size
Round pad	PAT-05	Φ5	29	PU tube Φ6 × Φ4
	PAT-06	Φ6	29	
	PAT-08	Φ8	29.5	

Φ10-Φ15

Pad type	Item	Disk diameter	Length B	Tube size
Round pad	PAT-10	Φ10	30.5	PU tube Φ6 × Φ4
	PAT-15	Φ15	32	



Outside graph dimension-PAFS series

Φ2~Φ3.5

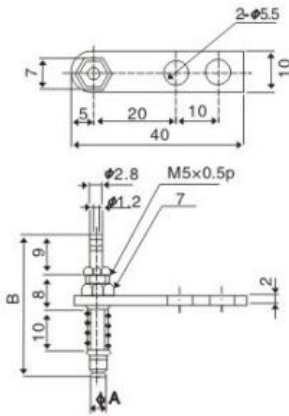

Φ5~Φ8

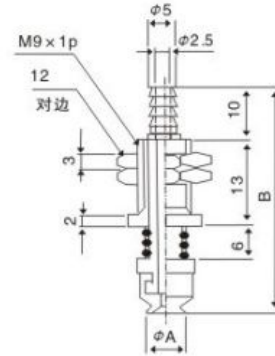

Φ10~Φ15

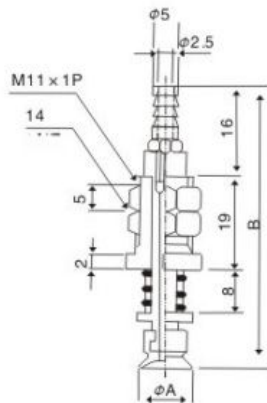

Φ25~Φ50

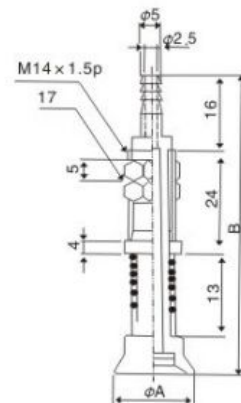

Φ2~Φ3.5

Pad type	Item	Disk diameter	Length	Tube size	Spring length
Round pad	PAFS-2	Φ2	33	PU tube	2,5,5
	PAFS-3.5	Φ3.5	33		
Ellipse pad	PAFS-2x4	2x4	33.7	Φ4xΦ2.5	
	PAFS-3.5x7	3.5x7	34.5		

Φ25~Φ50

Pad type	Item	Disk diameter	Length	Tube size	Spring length
Round pad	PAFS-20	Φ20	69.5	PU tube	6,15
	PAFS-25	Φ25	73.5		
	PAFS-30	Φ30	71.5	Φ6xΦ4	
	PAFS-35	Φ35	71		
	PAFS-40	Φ40	71		
	PAFS-50	Φ50	72		

Φ5~Φ8

Pad type	Item	Disk diameter	Length	Tube size	Spring length
Round pad	PAFS-05	Φ5	37.5	PU tube	3,10
	PAFS-06	Φ6	37.5		
	PAFS-08	Φ8	38	Φ6xΦ4	

Φ10~Φ15

Pad type	Item	Disk diameter	Length	Tube size	Spring length
Round pad	PAFS-10	Φ10	56.5	PU tube	4,10
	PAFS-15	Φ15	57	Φ6xΦ4	

Outside graph dimension-PATS series

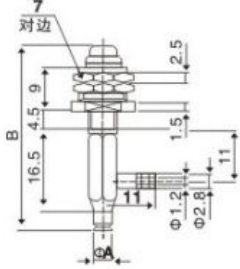
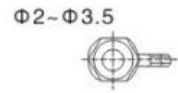

Φ10~Φ15

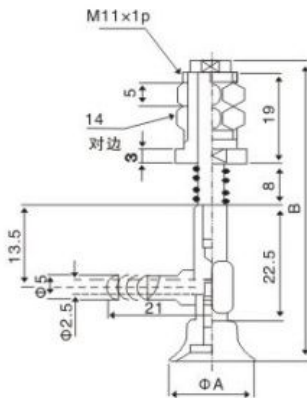

Φ5~Φ8

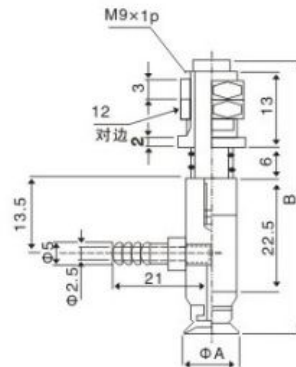

Φ25~Φ50

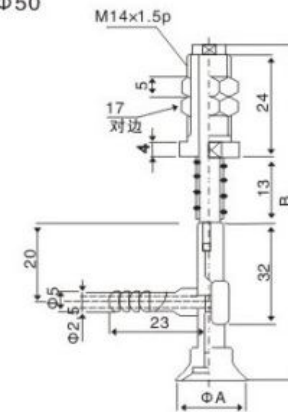

Φ2~Φ3.5

Pad type	Item	Disk diameter	Length B	Tube size	Spring length
Round pad	PATS-2	Φ2	35.5	PU tube	2.5, 5
	PATS-3.5	Φ3.5	35.5		
Ellipse pad	PATS-2×4	2×4	37.4	Φ4×Φ2.5	
	PATS-3.5×7	3.5×7	38.2		

Φ5~Φ8

Pad type	Item	Disk diameter	Length	Tube size	Spring length
Round pad	PATS-05	Φ5	51	PU tube	3, 10
	PATS-06	Φ6	51	Φ6×Φ4	
	PATS-08	Φ8	51.5		

Φ10~Φ15

Pad type	Item	Disk diameter	Length B	Tube size	Spring length
Round pad	PATS-10	Φ10	60	PU tube	4, 10
	PATS-15	Φ15	60	Φ6×Φ4	

Φ25~Φ50

Pad type	Item	Disk diameter	Length	Tube size	Spring length
Round pad	PATS-20	Φ20	83	PU tube	6, 15
	PATS-25	Φ25	87		
	PATS-30	Φ30	85		
	PATS-35	Φ35	87		
	PATS-40	Φ40	87		
	PATS-50	Φ50	88	Φ6×Φ4	